

**A FIELD COMPARISON OF NITROGEN REMOVAL
BY ON-SITE STANDARD AND PRESSURE DOSING
SEPTIC SYSTEMS IN THE NEW JERSEY PINELANDS**

*John F. Bunnell, Robert A. Zampella,
Mark D. Morgan, and Dennis M. Gray*

March 1996

Pinelands Commission
New Lisbon, New Jersey

ABSTRACT

Pressure dosing is an alternative to standard gravity feed for waste water distribution in on-site septic systems. We completed a study comparing nitrogen removal in eight pressure dosing and eleven standard septic systems in the New Jersey Pinelands. For all systems, the native soil was replaced with select fill composed of sand. All systems served new, single family homes. Septic and pump tanks were sampled directly and suction cup lysimeters were installed to sample waste water at three depths within the disposal field. Each was sampled quarterly for three years.

There was no significant difference in nitrogen removal between system types. Average system nitrogen removal rates of 40% and 48% were found for pressure dosing and standard systems, respectively. In both types of systems, most nitrogen removal occurred between the septic tank and the top zone of the disposal field. In most systems, there was little change in nitrogen between the top and bottom zones. At 1.5 m below the gravel/select fill interface, mean Cl^- corrected TN concentrations were 32.8 mg/l for pressure dosing systems and 34.0 mg/l for standard systems.



ACKNOWLEDGMENTS

We gratefully thank the twenty-six homeowners for their patience and cooperation during this monitoring program. We could not have initiated this program without the support and active participation of Ralph Good (deceased). We thank John Stokes, John LaMacchia, Janet Pierce, Sharon Griffin, and David Schock (Pinelands Commission) for their contribution to the study. Eric Vowinkel (US Geological Survey), Terry Bounds (Orenco Systems, Inc.), John Roe (New Jersey Department of Environmental Protection), and Andrea Bunnell reviewed the draft report. Thomas Barringer (US Geological Survey) provided statistical advice.



INTRODUCTION

Pressure dosing is an alternative to standard gravity flow for waste water distribution in on-site septic systems (Figure 1). In pressure dosing systems, waste water is discharged from the septic tank to the disposal field through low pressure doses.

Typically, organic nitrogen is the main form of waste water nitrogen that enters a septic tank. In the anaerobic (deoxygenated) septic tank environment, most of this organic nitrogen is converted to ammonium-nitrogen through ammonification (Table 1). When aerobic (oxygenated) conditions exist in the disposal field, ammonium-nitrogen from the septic tank is transformed into nitrate-nitrogen through the process of nitrification. If the nitrate-nitrogen encounters anaerobic conditions in the presence of a carbon source, it may be converted to nitrogen gas through denitrification. The nitrogen gas then dissipates into the atmosphere. Microorganisms are responsible for all three transformations.

Table 1. Nitrogen transformations

	Ammonification	
Organic N	—————→	NH_4^+ -N (ammonium-N)
	Nitrification (aerobic)	
NH_4^+ -N	—————→	NO_3^- -N (nitrate-N)
	Denitrification (anaerobic)	
NO_3^- -N	—————→	N_2 (nitrogen gas)

Sandy soils predominate in the New Jersey Pinelands (Markley 1979). It is generally assumed that the denitrification potential of sandy, well drained soils is low and that all nitrogen present in waste water eventually enters the groundwater as nitrate (Brown 1980, Robertson et al. 1991). Dosing of waste water may periodically create anaerobic conditions in the select fill or at the select fill/native soil interface (Harkin et al. 1979). Harkin et al. (1979) reported that mounded pressure dosing systems (Wisconsin mounds) removed 44% of the nitrate-nitrogen formed in the fill. They attributed this loss to denitrification occurring under anaerobic conditions. Results from other pressure dosing studies vary (Anonymous 1978, Cogger and Carlile 1984, Converse et al. 1991, Bomblat et al. 1994, Converse et al. 1994, Shaw and Turyk 1994).

In 1990, the Pinelands Commission and Rutgers University, Division of Pinelands Research, initiated a field study to compare the nitrogen removal capability of subsurface pressure dosing systems and standard gravity flow systems. The results of the study are presented in this report.

Pressure dosing septic system

Lateral View

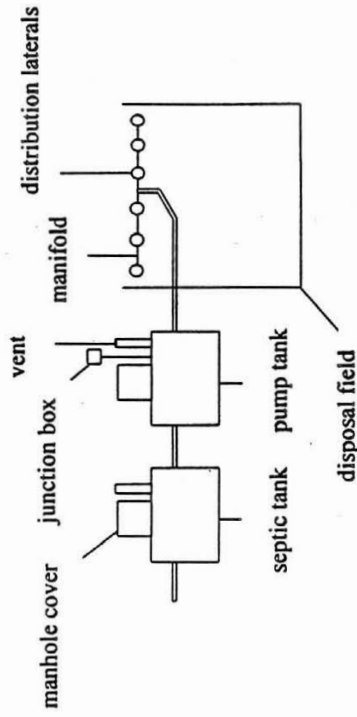

Vertical View

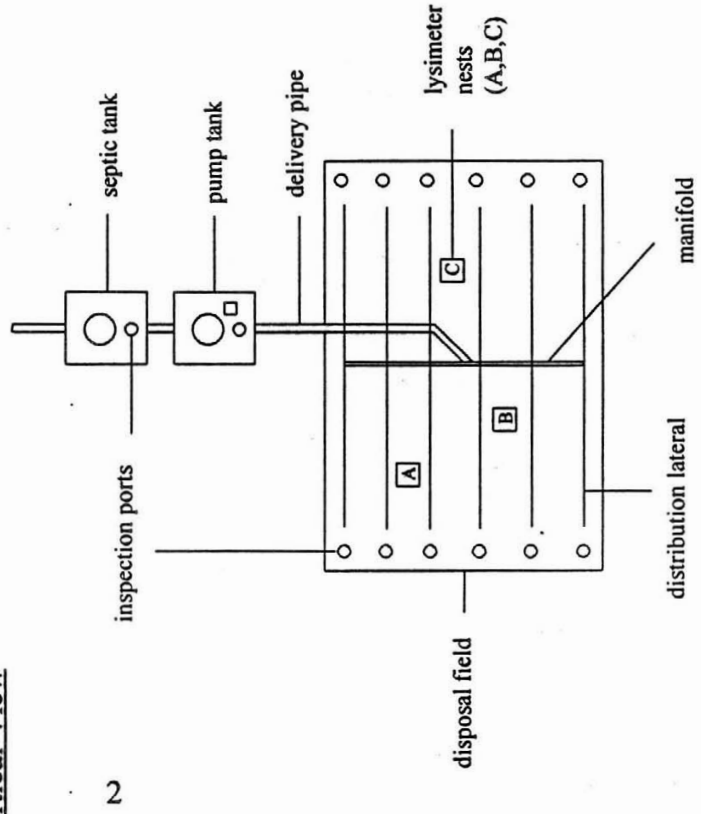

Standard septic system

Lateral View

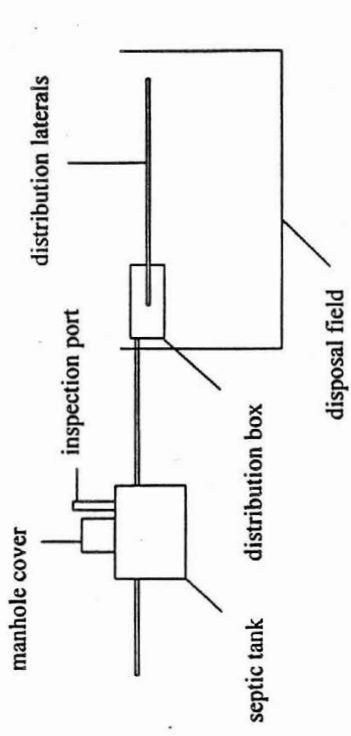

Vertical View

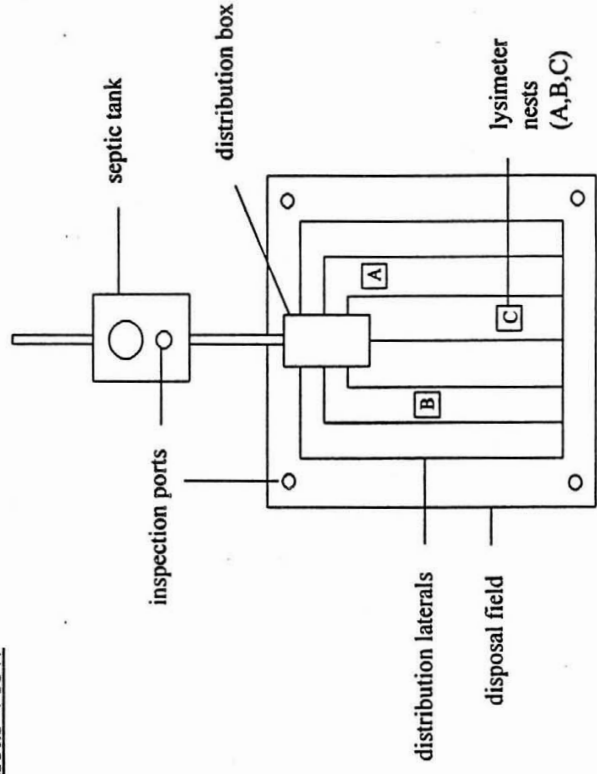

Figure 1. Lateral and vertical view of pressure dosing and standard systems.

MATERIALS AND METHODS

Study Systems

We monitored fifteen pressure dosing and eleven standard systems. System selection criteria included availability, depth to seasonal high water table, and site location. Availability was determined by construction schedules and time of occupation. Systems were clustered in three growth areas within the Pinelands (Figure 2). Sites were limited to those with moderately to excessively well drained soils with a seasonal high water table greater than 2.4 m below the land surface. All systems served new single family homes that were occupied year round. The installation of each system was governed by N.J.A.C. 7:9A *Standards for Individual Subsurface Sewage Disposal Systems*, inspected by the local county health department, and certified by the licensed designing engineer.

The standard septic systems consisted of a concrete septic tank leading to a distribution box. The distribution box delivers waste water through a series of distribution laterals that discharge the waste water over a gravel disposal bed (Figures 1 and 3). The pressure dosing systems included both a concrete septic tank and a concrete pump tank. A specific volume of waste water is periodically pumped through the laterals. In both systems, waste water percolates through the disposal bed and an underlying layer of sand (select fill) and into the native soil.

Disposal beds were composed of approximately 41 cm of washed gravel placed over a 1.2 m layer of select fill (Figure 3). The select fill consisted of either imported sand or native soil that was excavated, mixed, and replaced. All select fill met the same particle size specifications (Table 2). To conform to N.J.A.C. 7:9A, an additional 1.2 m of native soil was replaced in a standard system and a pressure dosing system due to the presence of hydraulically restrictive layers in the native soil. For the same reason, 3.7 m of native soil was replaced at a second standard system.

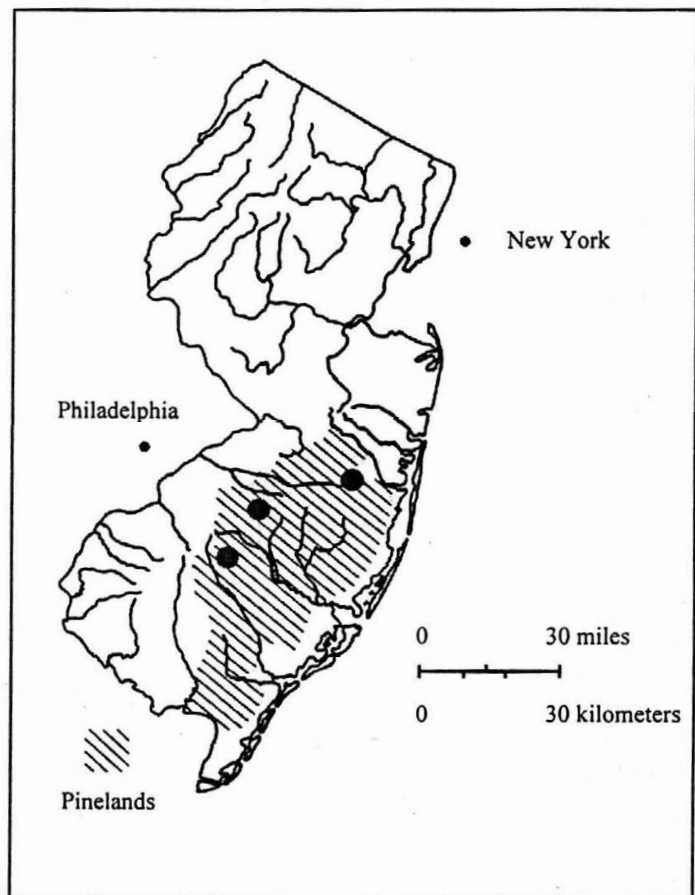

Figure 2. New Jersey Pinelands and study system cluster locations.

Table 2. Pinelands Commission particle size specifications for select fill.

1. Not more than 25% coarse fragments;
2. 85 - 95% sand;
3. 5 - 15% silt plus clay, with a minimum of 2% clay by weight;
4. Not less than 25% very coarse, coarse or medium sand; and
5. Less than 50% fine or very fine sand.

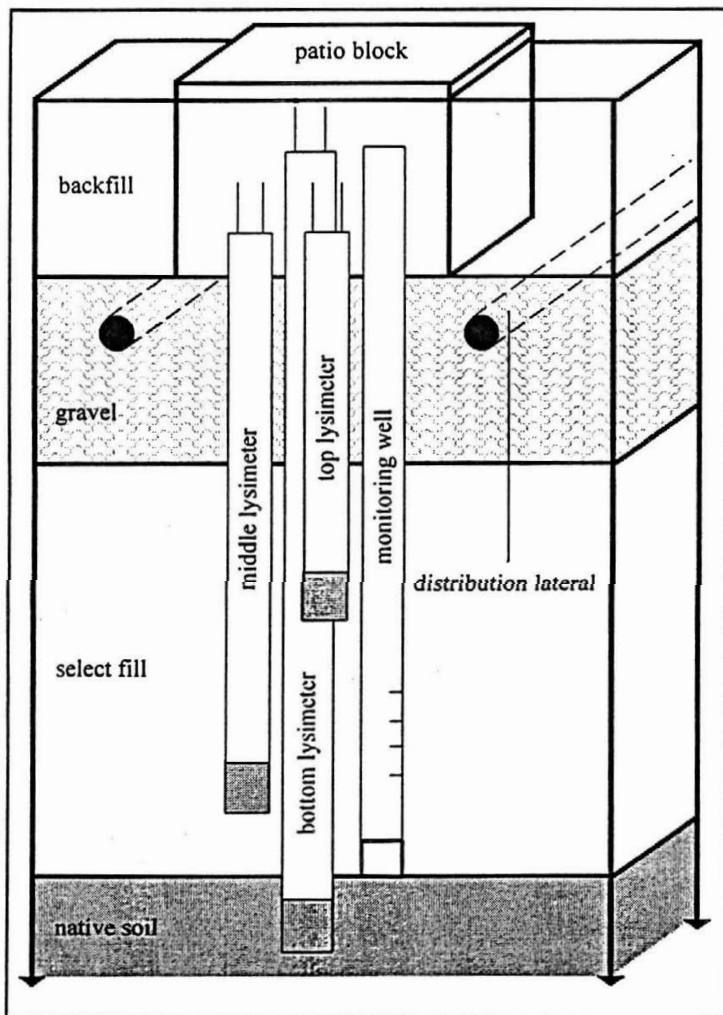

Figure 3. Cross section of a portion of a disposal field showing lysimeters and water-level monitoring well.

Monitoring Equipment

We used suction cup lysimeters (Figure 4) to sample waste water from the disposal field. The lysimeters were constructed using round bottom porous alundum cups (Soil Moisture Equipment Corporation, Santa Barbara, California). Ceramic cups have been used to sample water from unsaturated soils (Anonymous 1978, Starr and Sawhney 1980, Uebler 1984). We chose alundum cups because they are less reactive than ceramic cups. Based on results reported for ceramic cups, we assume that absorption and filtering of suspended particles that are greater than the 2.5 micron cup pore size are the only major biases possibly associated with use of the alundum cups. These biases, which vary among parameters, should only effect comparisons of waste water chemistry between the septic tank and the disposal field lysimeters. Chloride and pH changes are negligible after passage through ceramic cups (Peters and Healy 1988) and nitrate-nitrogen is not leached from or absorbed by ceramic cups (Wagner 1962, Hansen and Harris 1975). Ceramic cups have the capacity to adsorb

small amounts of ammonium-nitrogen (Wagner 1962). Because all dissolved organic carbon samples were passed through a 0.45 micron filter prior to laboratory analysis, changes between the septic tank and the top select fill zone cannot be attributed to filtering.

The disposal field was divided into three equal sections and a group (or nest) of three lysimeters was installed at randomly selected points within each section of each system (Figures 1 and 3). Within each nest, lysimeters extended 15 cm and 91 cm into the select fill and 31 cm below the select fill/native soil interface (Figure 3). A 2.5 cm diameter PVC pipe was installed with each nest of lysimeters to monitor standing water at the select fill/native soil interface.

Suction cup lysimeters require a tight contact with the surrounding soil to provide a hydraulic pathway for water to flow from the pores in the soil through the pores in the cups. We used a slurry of water and milled No. 200 mesh silica flour to create a connection between the soil and the cups in all but eight systems. The annular space around the lysimeters was backfilled and the annulus of the middle and bottom lysimeters were sealed with bentonite grout (a montmorillonite clay powder). The bentonite was added to prevent waste water from channeling along the lysimeter. For the first eight systems that we installed, a sample of select fill that passed through a No. 35 mesh sieve was used in the slurry and the annular space was not sealed with bentonite.

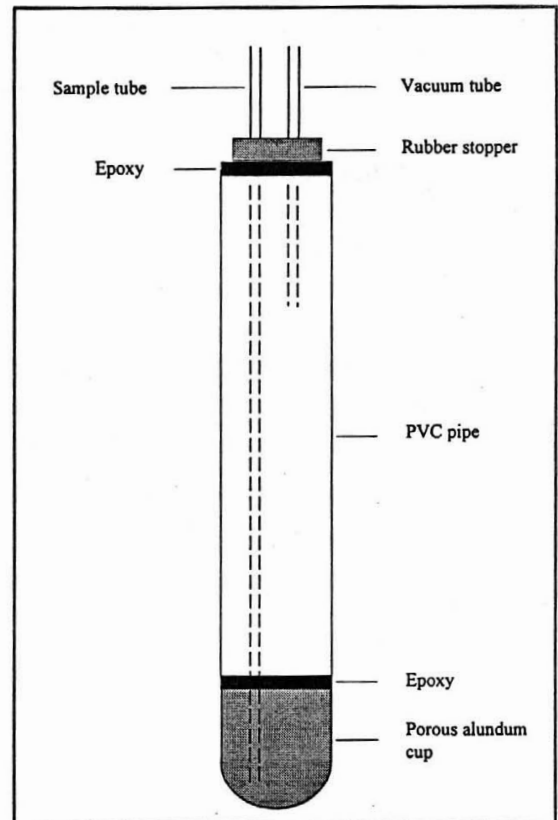

Figure 4. Suction cup lysimeter.

Fill Sampling

Fill samples were collected during the installation of each system. An auger was used to collect fill samples from 0 - 15 cm, 15 - 91 cm, 91 - 122 cm and 122 - 152 cm (the first 30 cm of native soil) within the disposal field. No fill sample was collected from 91 - 122 cm for systems 1 and 2. Initially, samples were taken from each level from all three lysimeter nests and a hydrometer analyses was performed on each sample. After determining that fill texture across the disposal field was uniform, we began compositing samples by depth for hydrometer analysis.

Waste Water Sample Collection

Field sampling was conducted from September 25, 1990 through March 1, 1995. Approximately twenty-four hours prior to sampling, a 70 - 80 centibar vacuum was applied to empty lysimeters using a hand pump. The following day, we collected waste water samples from the septic tank, the pump tank of pressure dosing systems, and the nine lysimeters. Only pump tank samples were collected from system 8. Samples were collected using a portable peristaltic pump. Tank samples were pumped directly into high density polyethylene bottles. Lysimeter samples were pumped into a graduated cylinder to measure volume before transferring them to high density

polyethylene bottles. The bottles, the graduated cylinder, and the pump tubes were thoroughly rinsed with deionized water prior to each sample collection.

Each sample was split into three parts. Redox potential (E_h), dissolved oxygen (DO), and temperature were measured in the field from one subsample. E_h and DO measurements were discontinued after a system was sampled for at least one year. The second subsample was preserved with 11 N sulfuric acid for laboratory analysis of, ammonium-nitrogen ($\text{NH}_4^+\text{-N}$), total Kjeldahl nitrogen (TKN), dissolved organic carbon (DOC), and total organic carbon (TOC - tank samples only). The third subsample was used for laboratory analysis of pH, alkalinity, chloride (Cl^-), nitrite-nitrogen ($\text{NO}_2^-\text{-N}$), and nitrate-nitrogen ($\text{NO}_3^-\text{-N}$). All samples used for laboratory analysis were placed on ice for transport to the laboratory. After sampling, lysimeters were flushed with deionized water.

We began sampling a system after the home was occupied for three to four months. Each system was sampled quarterly for three years. Systems were added to the monitoring program as they were constructed and occupied. Due to weather related cancellations and system construction delays, systems 21 - 26 were sampled more frequently during the third year to complete twelve sampling events. Systems 25 and 26 were included in the program late and were sampled on only ten dates.

Laboratory Analysis

Fill and chemical analyses were performed at the Rutgers, Division of Pinelands Research, field station. Laboratory quality control conformed to N.J. state certified laboratory techniques found in N.J.A.C. 7:18 *Regulations Governing Laboratory Certification and Standards of Performance*. Field blanks were analyzed to monitor sampling techniques. Constituent analyses were performed according to *Standard Methods for the Examination of Water and Waste Water* (APHA 1989) (Table 3).

Data Analysis

System Pool. Nineteen of the original twenty-six systems (eight pressure dosing and eleven standard systems) were included in the final analysis. Appendix 1 contains relevant septic system design specifications for these nineteen systems. All seven systems that we eliminated were pressure dosing systems. Systems 3 and 4 were dropped because of missing data points due to low sample volume in the majority of the lysimeters. Systems 5, 6, 14, and 16 were excluded because water softener backwash caused large fluctuations in Cl^- concentrations throughout the systems. System 8 was omitted because only pump tank samples were collected. Five of the seven systems eliminated were among those installed without the use of bentonite or No. 200 mesh silica flour.

Soil Texture. Select fill and native soil textures were classified using the U.S. Department of Agriculture system (Gee and Bauder 1986). Particle size distribution and texture classifications were evaluated to determine if substantial vertical changes occurred within systems and if differences existed among systems.

Data Editing. Concentrations of some parameters were reported as below detection limit (Table 3). NO_3^- -N concentrations were normally below detection only in the septic and pump tank samples where nitrogen concentrations were highest. Low NO_3^- -N concentrations were expected because of the anaerobic conditions found in the tanks. Because NO_2^- -N concentrations were usually below detection and rarely exceeded one percent of the total nitrogen in any sample, NO_2^- -N was included in the reported NO_3^- -N values. Throughout this report, NO_3^- -N refers to $\text{NO}_2^- + \text{NO}_3^-$ -N. Concentrations of NH_4^+ -N and TKN were sometimes below detection in the lysimeter samples. Prior to analysis, censored data for these parameters were equated to zero. We deleted censored Cl^- values because Cl^- concentrations were used in constituent ratios to account for dilution. Because detection limits were relatively low, converting censored values to zero had a minimal effect on our results.

Malfunctioning lysimeters and inadequate lysimeter volume complicated data analysis. To ensure consistency in daily sample replication and comparisons between zones (septic tank vs. bottom zone, top zone vs. bottom zone), we used data collected only on those dates when samples were available for all lysimeters included in the analysis. For the majority of systems, nitrogen and Cl^- data were available for all three lysimeter nests. In several systems, samples were consistently available from two nests. Fewer data points were available for DOC, pH and alkalinity because the analysis of nitrogen species and Cl^- was given priority when sample volume was low. For these parameters, we included those nests that provided the maximum number of sampling dates.

Table 3. Waste water chemistry detection limits. Units are mg/l unless otherwise noted.

<u>Parameter</u>	<u>Detection Limit</u>	<u>Methods of Chemical Analysis</u>
Cl^- *	1.0	Measured using a Dionex 2000i Ionchromatograph
DOC and TOC	0.5	Digested using the persulfate-ultraviolet oxidation technique and measured on a Dohrmann DC-80 organic carbon analyzer
NO_2^- -N *	0.02	Measured colorimetrically by the N-(1-naphthyl)-ethylene-diamine dihydrochloride method
NO_3^- -N *	0.5	Measured using a Dionex 2000i Ionchromatograph
NH_4^+ -N *	0.2	Measured using an Orion ammonia-selective electrode
TKN *	0.5	Digested using mercuric sulfate and then measured with an Orion ammonia electrode
DO	0.5	Measured using a YSI model 57 meter
Alkalinity	----	Titration method
pH	0.01 unit	Measured using an Orion SA 250 meter
E_h	0.1 millivolt	Measured using an Orion SA 250 meter
Temperature	0.5 °C	Measured using an Orion SA 250 meter (after a system was sampled at least one year, a mercury thermometer was used)

* parameters most frequently reported as below detection limit.

Total Nitrogen. Using the Mann-Whitney U Test, we compared the average percent change in total nitrogen that occurred between the septic tank and the bottom zone of standard and pressure dosing systems. Total nitrogen (TN) was calculated as the sum of NO_3^- -N and TKN. This analysis was completed to determine if there was a significant difference in overall nitrogen removal between the two types of systems. The Wilcoxon Matched Pairs Test was used to analyze daily changes in TN that occurred between the top and bottom zones within each system. This was done to determine if significant changes in TN occurred within the select fill of individual systems and if differences between the pools of standard and pressure dosing systems were apparent. Results for both statistical tests were considered significant at $p \leq 0.05$.

To provide a consistent comparison of the two system types, the septic tank was used as the waste water input for pressure dosing systems rather than the pump tank. Several calculations were required to obtain a mean percent change in TN for each of the systems (Table 4). First, we calculated mean TN concentrations for the septic tank and each of the bottom lysimeters. Mean concentrations for the entire sampling period were compared rather than daily means because waste water collected from the lysimeters on an individual sampling date was extracted from the disposal field over a twenty-four hour period and may have included an earlier dose or slug than that sampled from the septic tank.

Dilution can be the result of precipitation or lawn irrigation. Because Cl^- is conservative, changes in its concentration can be attributed primarily to dilution (Harkin et al. 1979, Bomblat et al. 1994, Converse et al. 1994). The ratio of the mean Cl^- concentration for the septic tank and each bottom lysimeter ($\text{Cl}_s:\text{Cl}_b$) was used to correct the mean bottom lysimeter nitrogen concentrations for dilution. The mean TN values for each bottom lysimeter were Cl^- corrected individually to account for variations in TN and Cl^- concentrations due to uneven effluent distribution and dilution across the disposal field. This variation was especially apparent in standard systems. The bottom Cl^- corrected TN concentrations were then averaged and a percent change in TN was calculated. In two systems (15 and 18), data were available for only two of the three bottom lysimeters.

We assume that comparisons of daily changes in TN that occurred between the top and bottom zones are valid because the high permeability (range of 5 - 20 in/hr, Appendix 1) of the select fill minimizes the waste water dose or slug effect between zones. Daily constituent concentrations varied substantially across the disposal field and top zone concentrations could not be corrected for dilution due to the potential septic tank/top zone slug effect. Thus, we were not able to average daily concentrations. The use of TN: Cl^- ratios (Shaw and Turyk 1994, Converse et al. 1994) allowed us to circumvent this problem. Using the mean of the three individual nest ratios for each zone, we compared the daily TN: Cl^- ratios for the top and bottom zones. For six systems (systems 9, 12, 15, 17, 18, and 19), only two nests were included in the analysis.

Mean and quartile TN: Cl^- ratios for the septic tank and all three disposal field zones are shown graphically. Daily ratios were used to calculate the summary statistics. The middle lysimeter sample number may be slightly less than that shown for the other sampling zones.

Ancillary Parameters. Alkalinity, DOC, pH, DO and E_7 (E_h corrected to pH 7.0) were used to characterize the nitrogen environment in the septic tank and the top and bottom zones. For each system, mean and quartile alkalinity, DOC, pH, and DOC: Cl^- values were calculated. Mean pH was calculated using hydrogen ion concentrations. Because the peristaltic pump that we used may have aerated samples, E_7 and DO data were not used directly. We calculated the average percent change in E_7 and DO between the septic tank and top zone and between the top and the bottom zone for both system types to assess relative changes in these parameters.

Table 4. An example of calculating percent change in total nitrogen (TN) between the septic tank and the bottom zone. Concentrations are in mg/l.

Sampling zone	Mean TN	Mean Cl ⁻	Cl _s /Cl _b				Corrected TN
Septic tank	60.0	40.0					
A bottom lysimeter	30.0	30.0	40/30	=	1.3	1.3(30)	= 40.0
B bottom lysimeter	20.0	25.0	40/25	=	1.6	1.6(20)	= 32.0
C bottom lysimeter	25.0	35.0	40/35	=	1.1	1.1(25)	= <u>28.6</u>
Mean corrected bottom zone TN							33.5

$$\text{TN change (septic tank to bottom zone)} = (33.5 - 60.0) / 60.0 = -44\%$$

RESULTS AND DISCUSSION

Pressure dosing and standard system septic tank waste water chemistry was similar (Table 5). The average pump tank and septic tank TN concentrations of pressure dosing systems were equal. Nearly all of the septic tank nitrogen was TKN and most of the TKN was present as NH₄⁺-N (Table 6). The percentage of septic tank TKN composed of NH₄⁺-N is comparable to that reported by others (Walker et al. 1973, Magdoff et al. 1974). The near total absence of NO₃⁻-N reflects the anaerobic conditions that typically exist in septic tanks.

NO₃⁻-N was the dominant form of nitrogen in the select fill of both system types. The predominance of NO₃⁻-N in the top zone indicates that nitrification occurred above or within the upper 15 cm of the select fill (Table 6). This is supported by the associated decrease in pH and alkalinity (Figures 5 and 6). A decrease in pH may be the result of the generation of hydrogen ions from the oxidation of NH₄⁺-N to NO₃⁻-N during nitrification, and a decrease in alkalinity may be caused by the neutralization of these hydrogen ions (Andreoli et al. 1979). Conversion of TKN and NH₄⁺-N to NO₃⁻-N continued as the waste water percolated through the select fill.

The relatively rapid conversion of TKN to NO₃⁻-N is typical in unsaturated sands (Walker et al. 1973, Anonymous 1978). All select fill and native soil samples were composed of sand or loamy sand (Appendix 2) and the fill was similar in pressure dosing and standard systems (Table 7). The vertical homogeneity of the select fill indicates the lack of textural unconformities that can result in ponding of infiltrating waste water and anaerobic conditions. The percent change in E₇ and DO highlights the difference in the aeration state between the septic tank and the select fill (Table 8).

Table 5. Septic and pump tank waste water summary statistics for pressure dosing and standard systems.

<u>Pressure Dosing Systems</u>								
Septic Tank Parameter	N	Mean	Standard Deviation	Median	Minimum	Maximum	25th Percentile	75th Percentile
pH	8	7.06	0.38	7.22	6.56	8.20	6.88	7.45
Cl ⁻	8	32	12	29	19	51	24	41
TOC	8	83.4	25.2	83.8	45.0	123.1	65.9	100.1
DOC	8	55.6	16.7	53.1	33.3	89.0	45.8	62.3
alkalinity	8	220.8	49.7	207.0	160.2	322.3	191.7	243.1
NO ₂ ⁻ +NO ₃ ⁻ -N	8	0.3	0.6	0.1	0.0	1.6	0.0	0.4
NH ₄ ⁺ -N	8	41.7	9.5	39.3	30.5	56.2	35.1	49.0
TKN	8	53.3	11.5	48.3	43.3	73.1	45.4	61.3
TN	8	53.7	11.3	48.4	43.5	73.1	46.6	61.4
Pump Tank								
pH	8	7.25	0.21	7.21	7.01	7.66	7.12	7.33
Cl ⁻	8	34	13	29	20	54	25	46
TOC	8	68.9	22.5	71.8	39.7	96.7	49.1	86.6
DOC	8	42.1	13.4	39.3	25.3	61.3	32.1	53.7
alkalinity	8	257.8	49.7	237.4	209.2	349.8	225.5	288.7
NO ₂ ⁻ +NO ₃ ⁻ -N	8	0.1	0.3	0.0	0.0	0.8	0.0	0.1
NH ₄ ⁺ -N	8	44.7	7.8	43.1	35.1	57.8	39.1	50.1
TKN	8	54.4	8.4	53.0	44.7	69.3	48.2	59.5
TN	8	54.5	8.3	53.0	44.7	69.3	48.6	59.5
<u>Standard Systems</u>								
Septic Tank Parameter	N	Mean	Standard Deviation	Median	Minimum	Maximum	25th Percentile	75th Percentile
pH	11	7.02	0.39	7.20	5.83	8.15	7.00	7.45
Cl ⁻	11	34	13	32	19	63	23	42
TOC	11	94.3	23.4	88.1	65.5	134.4	75.1	114.5
DOC	11	62.7	14.2	58.7	46.8	91.9	51.2	75.5
alkalinity	11	294.1	121.1	285.9	193.1	624.6	203.6	322.4
NO ₂ ⁻ +NO ₃ ⁻ -N	11	0.1	0.1	0.0	0.0	0.5	0.0	0.1
NH ₄ ⁺ -N	11	49.5	18.8	44.2	31.3	91.7	32.9	57.1
TKN	11	63.2	21.2	58.5	39.7	104.8	45.7	78.4
TN	11	63.3	21.2	58.5	39.8	104.8	45.7	78.4

The average decrease in TN between the septic tank and the bottom zone was 40% for pressure dosing systems and 48% for standard systems (Figure 7). The difference between the two systems was not significant (U-test, $N_1=8$, $N_2=11$, $p \leq 0.05$). In most systems, no change in the TN:Cl⁻ ratio was found between the top and bottom zones. A significant change was observed in only two pressure dosing systems and three standard systems (Figure 8). Similar results were obtained when changes between top and bottom zones within individual nests were evaluated.

The average Cl⁻ corrected TN and NO₃⁻-N concentrations in waste water for the bottom zone of pressure dosing systems were 32.8 mg/l and 31.4 mg/l (Table 6). For standard systems, the mean concentrations for these constituents were 34.0 mg/l and 32.1 mg/l. Harkin et al. (1979) found an average of 19.5 mg/l NO₃⁻-N at a depth of 55 cm beneath the native soil of Wisconsin mound systems. This substantially lower concentration was attributed to denitrification at the sand fill/native soil interface and within the native soil.

In the majority of systems, most nitrogen attenuation occurred between the septic tank and the top zone (Figure 8). It is unlikely that denitrification is the main reason for the decrease because nitrification appears to be the principal nitrogen transformation occurring in the upper 15 cm of select fill. A more probable mechanism is the formation of a mat, which is a layer of microorganisms and solids that accumulates at the gravel/select fill interface. Nitrogen can be bound as microbial biomass and collect at this interface through sorption of NH₄⁺-N to soil and organic material and physical filtering of particulate matter (Walker et al. 1973, Magdoff et al. 1974). Nitrogen accumulation within the soil material has been reported in other studies (Walker et al. 1973, Andreoli et al. 1979, Hoover et al. 1991). Harkin et al. (1979) found that approximately half of the nitrogen from the septic tank waste water remained in the pressure dosing disposal field mounds as organic nitrogen.

In all but five systems, nitrogen was similar between the top and bottom zones. Denitrification may be responsible for differences in the five systems (Figure 8). Although we did not observe ponding (i.e., an indirect indicator of anaerobic conditions) in the monitoring wells at the select fill/native soil interface of these five systems, DOC data suggest that denitrification may have occurred. Carbon is needed to fuel denitrification (Sikora and Keeney 1976). All five systems were among those systems displaying the greatest decrease in DOC concentration (Figure 9) or DOC:Cl⁻ ratios (Figure 10).

CONCLUSION

The subsurface pressure dosing and standard septic systems that we studied demonstrated a similar capacity for nitrogen attenuation. Between the septic tank and the bottom of the disposal field, the mean TN concentration was reduced by 40% in pressure dosing systems and by 48% in standard systems. The difference in nitrogen attenuation between the system types was not statistically significant. A significant decrease in nitrogen from the top to the bottom select fill zone was found in only two pressure dosing and three standard systems. Denitrification is a possible mechanism for this loss.

It is apparent from this study that subsurface pressure dosing and standard systems promote nitrification within the select fill but have low potential for NO₃⁻-N removal through denitrification in Pinelands sands. On average, 32.8 mg/l and 34.0 mg/l TN was found in the waste water discharged from the disposal field of pressure dosing and standard systems, respectively.

Table 6. Mean Cl⁻ corrected TN concentrations (mg/l) and composition of TN for pressure dosing systems (N=8) and standard systems (N=11).

	<u>Percent of total nitrogen</u>				
	TN	NO ₂ ⁻ +NO ₃ ⁻ -N	NH ₄ ⁺ -N	Organic N	TKN
Pressure Dosing Systems					
Septic tank	53.7	<1.0	77.3	22.0	99.3
Top zone	37.0	77.0	17.3	5.7	23.0
Bottom zone	32.8	95.7	1.2	3.0	4.2
Standard Systems					
Septic tank	63.3	<1.0	81.5	18.3	99.8
Top zone	41.5	80.2	12.3	7.5	19.8
Bottom zone	34.0	94.4	2.1	3.5	5.6

Table 7. Summary of select fill¹ and native soil composition in pressure dosing (N=8) and standard septic systems (N=11). Particle sizes reported as percentages. Standard deviations are shown in parentheses.

<u>Particle Size</u>	<u>Particle Size Distribution</u>			
	<u>Pressure Dosing Systems</u>		<u>Standard Systems</u>	
	<u>Select Fill</u>	<u>Native Soil</u>	<u>Select Fill</u>	<u>Native Soil</u>
Sand				
Mean	90.9 (4.1)	93.5 (4.6)	90.7 (3.3)	90.8 (3.6)
Median	91.0	94.5	91.0	92.0
1st Quartile	88.5	91.5	88.0	89.0
3rd Quartile	94.0	97.0	94.0	93.0
Silt				
Mean	3.8 (2.3)	3.0 (2.5)	4.2 (1.6)	3.9 (2.9)
Median	3.0	2.7	3.9	3.0
1st Quartile	2.3	1.0	2.7	2.0
3rd Quartile	5.7	4.3	5.3	5.0
Clay				
Mean	5.3 (2.8)	3.8 (2.1)	5.0 (2.2)	5.4 (2.9)
Median	4.0	3.0	4.3	5.0
1st Quartile	3.4	2.6	4.0	3.0
3rd Quartile	8.0	4.5	7.0	8.0

¹Select fill statistics are based on individual system means.

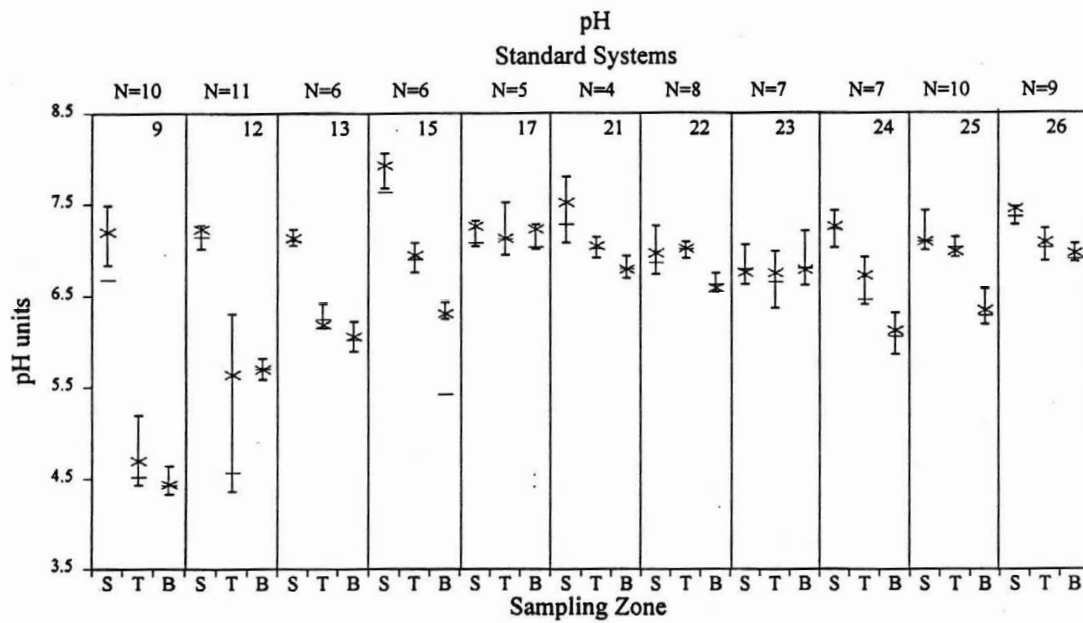
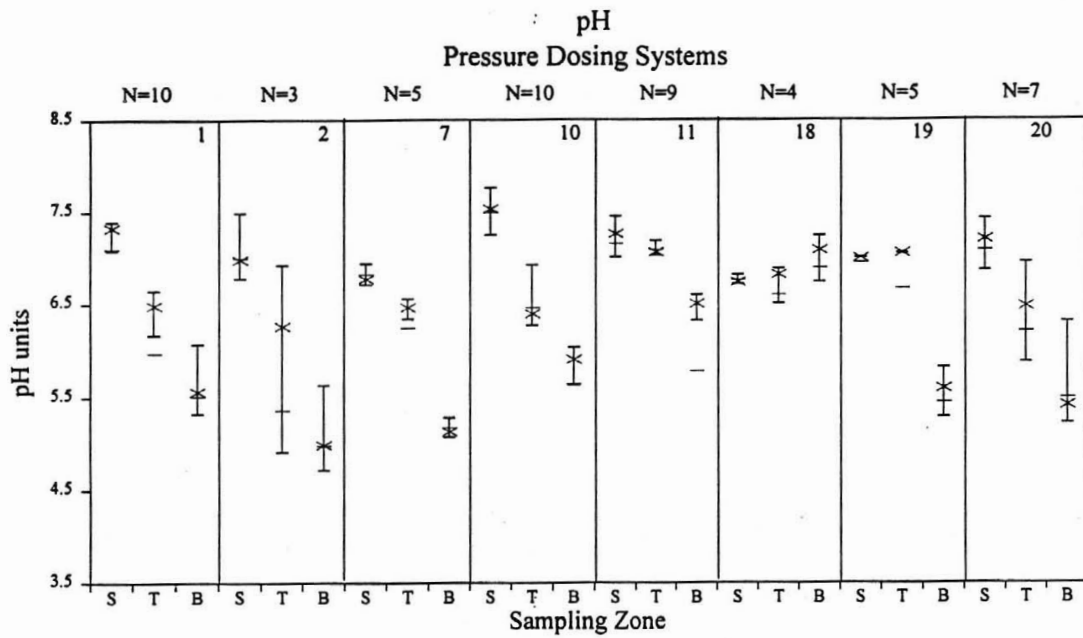

┌─── 75th Percentile
 │─── Mean
 ×── Median
 └─── 25th Percentile

Figure 5. pH for the septic tank (S), top zone (T) and bottom zone (B) for all systems. Sample number (N) and system number are shown at the top of each graph.

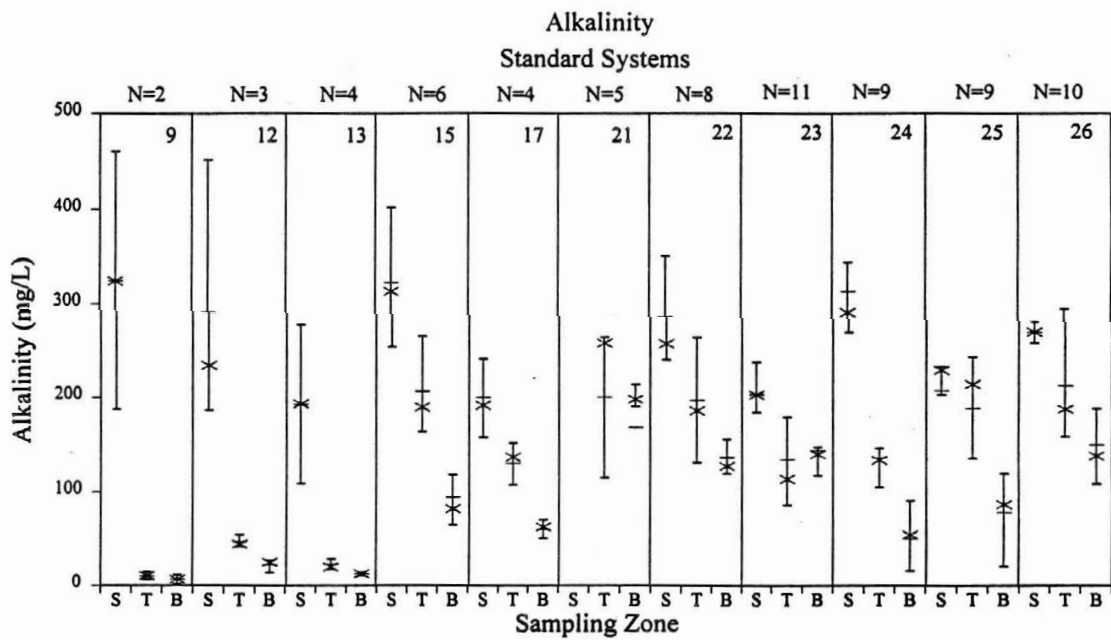
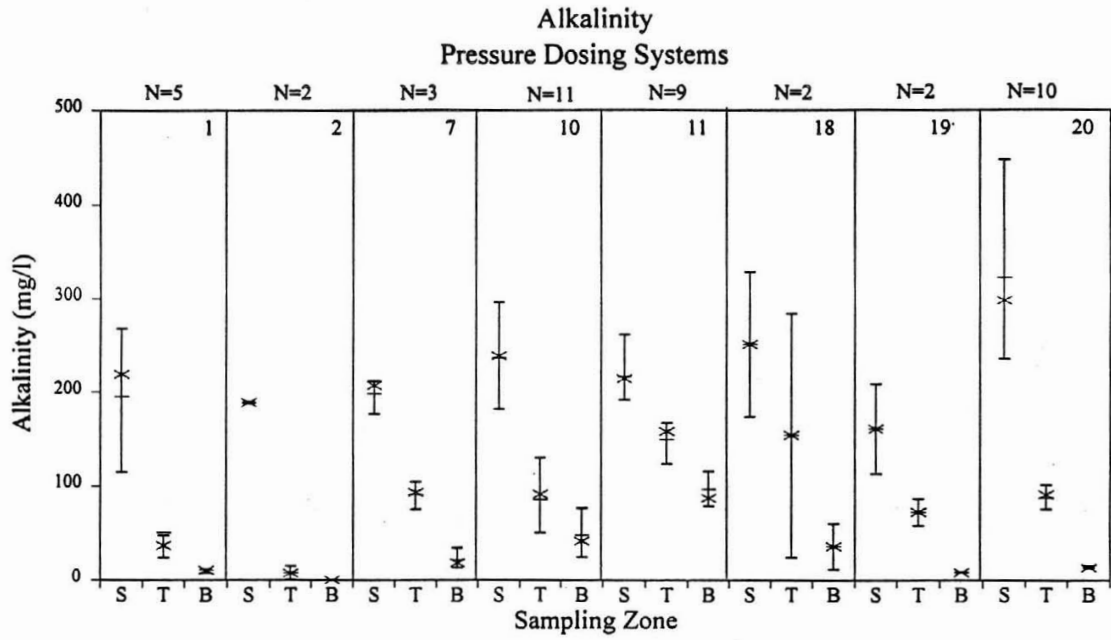

┌─── 75th Percentile
 ─── Mean
 ×── Median
 └─── 25th Percentile

Figure 6. Alkalinity for the septic tank (S), top zone (T), and bottom zone (B) for all systems. Sample number (N) and system number are shown at the top of each graph. For the septic tank for system 21, first quartile = 509.95, mean = 624.60, median = 620.25, third quartile = 670.50.

Table 8. Mean percent increase in dissolved oxygen (DO) and redox potential (E₇) between the septic tank, top zone and bottom zone for pressure dosing (N=7) and standard systems (N=11).

	<u>Mean percent increase</u>	
	DO	E ₇
Pressure Dosing Systems		
Septic tank - top zone	157.1	214.3
Top zone - bottom zone	1.6	14.4
Standard Systems		
Septic tank - top zone	181.3	229.0
Top zone - bottom zone	3.9	11.5

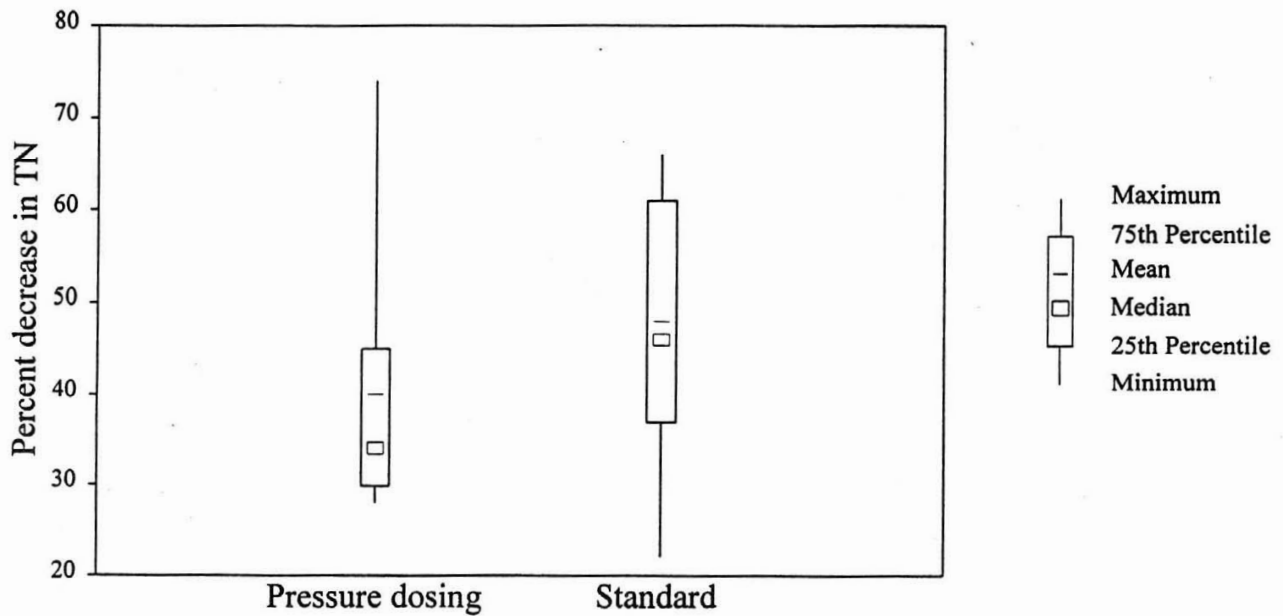
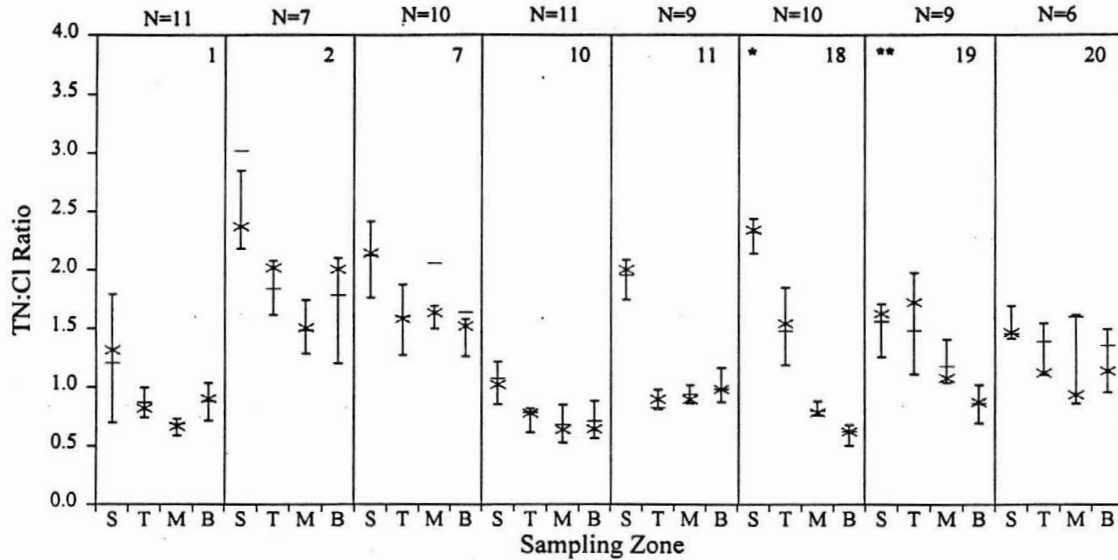
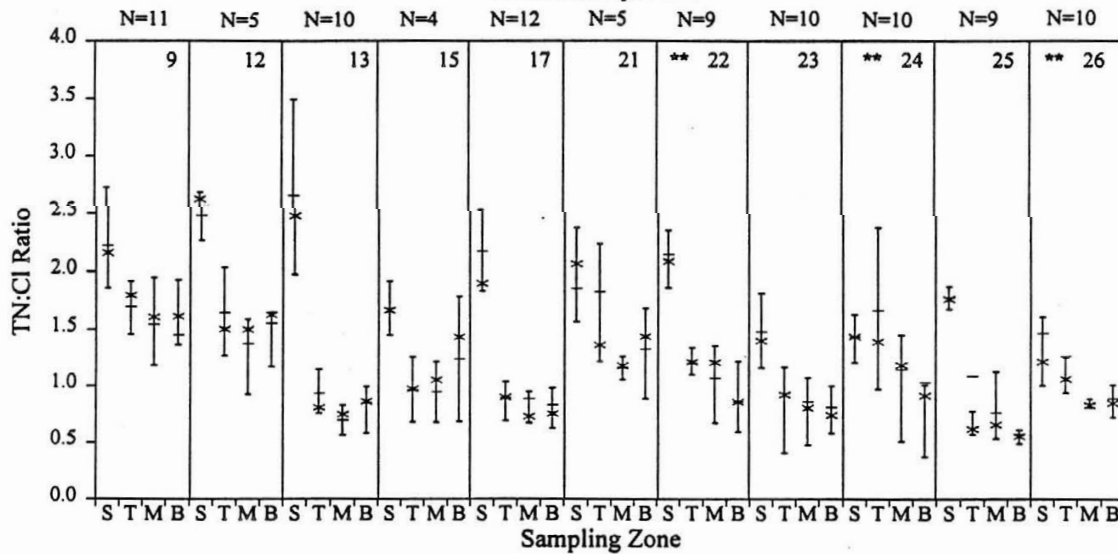

Figure 7. Summary statistics for percent decrease in total nitrogen for pressure dosing (N=8) and standard systems (N=11), U-test, $p \leq 0.05$.

**Total Nitrogen To Chloride Ratios
Pressure Dosing Systems**



**Total Nitrogen To Chloride Ratios
Standard Systems**



┌─── 75th Percentile
 ┌─── Mean
 x─── Median
 └─── 25th Percentile

Figure 8. Total nitrogen to chloride (TN:Cl) ratios for the septic tank (S), top zone (T), middle zone (M), and bottom zone (B) for all systems analyzed. Sample number (N) and system number are shown at the top of each graph. Significant changes in nitrogen from top to bottom indicated by asterisks (** = $p \leq 0.05$ and * = $p \leq 0.01$).

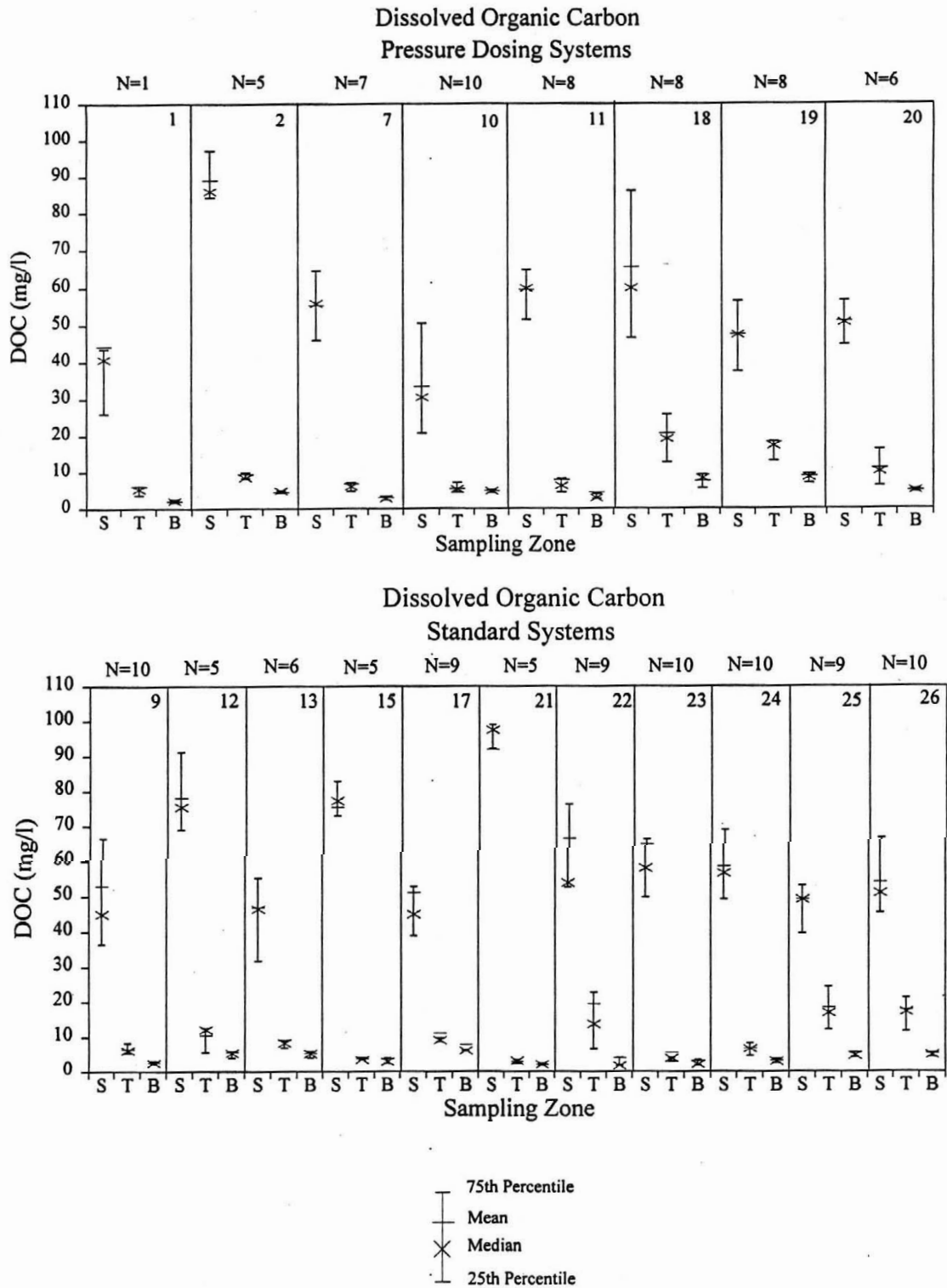
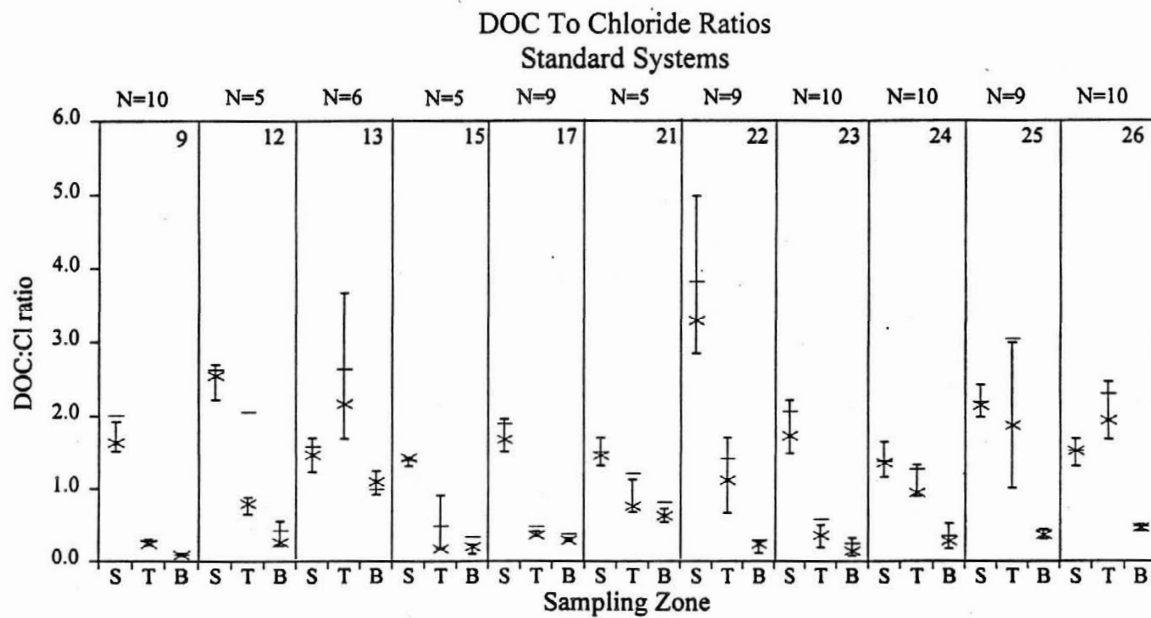
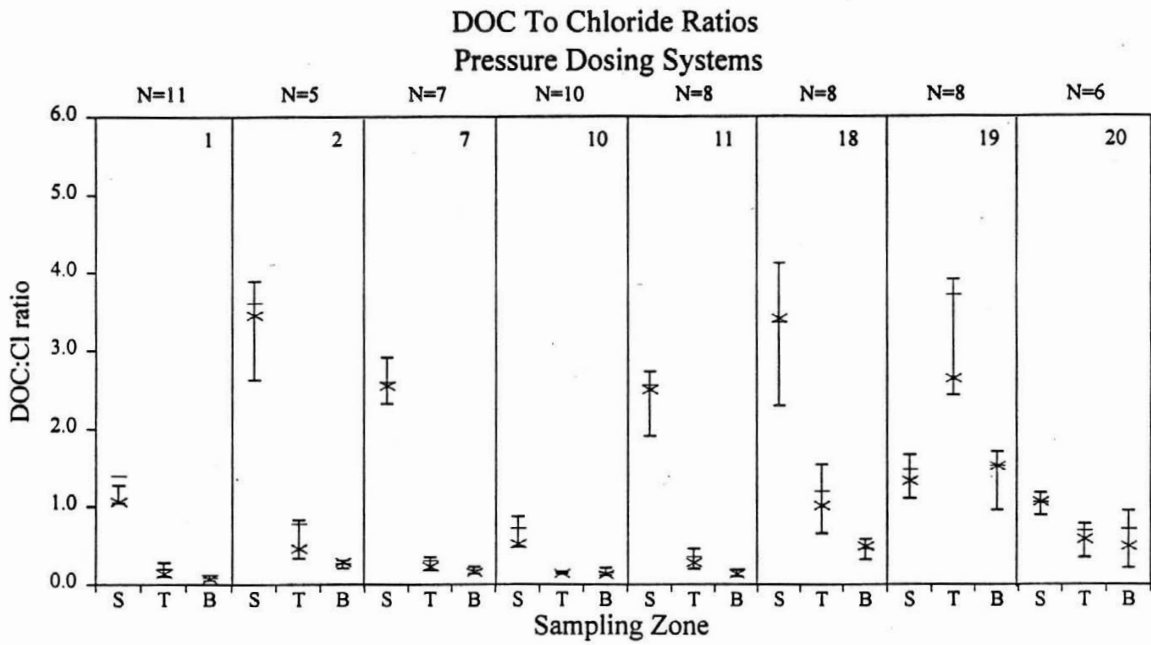

Figure 9. Dissolved organic carbon (DOC) concentrations for the septic tank (S), top zone (T) and bottom zone (B) for all systems. Sample number (N) and system number are shown at the top of each graph.



┌─── 75th Percentile
 ─── Mean
 X── Median
 └─── 25th Percentile

Figure 10. Dissolved organic carbon to chloride (DOC:Cl⁻) ratios for the septic tank (S), top zone (T), and bottom zone (B) for all systems. Sample number (N) and system number are shown at the top of each graph.

Literature Cited

APHA-AWWA-WPCF. 1989. Standard Methods for the Examination of Water and Waste Water. 17th ed. Am. Public Health Assoc., Washington, DC.

Anonymous. 1978. A field study of treatment vs. depth of sand fill in a mound system. Land and Water Resources, Maine University, Orono, Maine. Prepared for the Office of Water Research and Technology, Washington, DC. 91 pp.

Andreoli, A., N. Bartilucci, R. Forgione, R. Reynolds. 1979. Nitrogen removal in a subsurface disposal system. *J. WPCF*, 51(4):841-854.

Bomblat, C., D.C. Wolf, M.A. Gross, E.M. Rutledge, and E.E. Gbur. 1994. Field performance of conventional and low pressure distribution septic systems. *In On-site Waste Water Treatment. Proceedings of the International Symposium on Individual and Small Community Sewage Systems.* ASAE. St. Joseph, Michigan. pp 444-453.

Brown, K.W. 1980. An assessment of the impact of septic leach fields, home lawn fertilization and agricultural activities on groundwater quality. Prepared for the New Jersey Pinelands Commission. 104 pp.

Cogger, C.G., B.L. Carlile. 1984. Field performance of conventional and alternative septic systems in wet soils. *J. Environ. Qual.*, 13(1):137-142.

Converse, J.C., M.E. Kean, E.T. Tyler, J.O. Peterson. 1991. Bacterial and nitrogen removal in Wisconsin at-grade on-site systems. *In On-site Waste Water Treatment. Proceedings of the National Symposium in Individual and Small Community Sewage Systems.* ASAE. St. Joseph, Michigan. pp 46-61.

Converse, J.C., E.J. Tyler, S.G. Litman. 1994. Nitrogen and fecal coliform removal in Wisconsin mound system. *In On-site Waste Water Treatment. Proceedings of the International Symposium on Individual and Small Community Sewage Systems.* ASAE. St. Joseph, Michigan. pp 514-525.

Gee, G.W. and J.W. Bauder. 1986. *In Methods of Soil Analysis. Part I: Physical and Mineralogical Methods*, A. Klute (ed). American Society of Agronomy and the Soil Science Society of America, Madison, Wisconsin. pp 383-411.

Hansen, E.A. and A.R. Harris. 1975. Validity of soil-water samples collected with porous ceramic cups. *Soil Sci. Soc. Amer. Proc.* 39:528-536.

Harkin, J.M., C.J. Fitzgerald, C.P. Duffy, D.G. Kroll. 1979. Evaluation of mound systems for purification of septic effluent. Technical Report Wis WRC 79-05. Water Resources Center, University of Wisconsin-Madison, Madison, WI 53706. 107 pp.

- Hoover, M.T., A. Amoozegar, D. Weymann. 1991. Performance assessment of sand filter, low pressure pipe systems in slowly permeable soils of Triassic Basin. *In On-site Waste Water Treatment. Proceedings of the National Symposium in Individual and Small Community Sewage Systems.* ASAE. St. Joseph, Michigan. pp 324-337.
- Magdoff, F.R., J. Bouma, and D.R. Keeney. 1974. Columns representing mound-type disposal systems for septic tank effluent: II. Nutrient transformations and bacterial populations. *J. Environ. Qual.*, 3(3):228-234.
- Markley, M.L. 1979. Soil Series of the Pine Barrens. *In Pine Barrens: Ecosystem and Landscape*, R.T.T. Forman (ed). Academic Press, New York, New York. pp 81-92.
- Peters, C.A. and R.W. Healy. 1988. The representativeness of pore water samples collected from the unsaturated zone using pressure-vacuum lysimeters. *GWMR*. Spring.
- Robertson, W.D., J.A. Cherry, and E.A. Sudicky. 1991. Ground-water contamination from two small septic systems on sand aquifers. *Ground Water*, 29(1):82-92.
- Shaw B., N.B. Turyk. 1994. Nitrate-N loading to groundwater from pressurized mound, in ground and at grade septic systems. *In On-site Waste Water Treatment. Proceedings of the International Symposium on Individual and Small Community Sewage Systems.* ASAE. St. Joseph, Michigan. pp 504-513.
- Sikora, L.J. and D.R. Keeney. 1976. Denitrification of nitrified septic tank effluent. *Journal WPCF*, 48(8):2018-2025.
- Starr, J.L. and B.L. Sawhney. 1980. Movement of nitrogen and carbon from a septic systems drainfield. *Water, Air, and Soil Pollution*. 13:113-123.
- Uebler, R.L. 1984. Effect of loading rate and soil amendments on inorganic nitrogen and phosphorus leached from a waste water soil absorption system. *J. Environ. Qual.*, 13(3).
- Wagner, G.H. 1962. Use of porous ceramic cups to sample soil water within the profile. *Soil Sci.* 94:379-386.
- Walker, W.G., J. Bouma, D.R. Keeney, and F.R. Magdoff. 1973. Nitrogen transformations during subsurface disposal of septic tank effluent in sands: I. Soil transformations. *J. Environ. Qual.*, 2(4):475-480..

Appendix 1. System design specifications for pressure dosing and standard septic systems.

Pressure Dosing Systems																			
Site	Soil Series	Lot Size (ac)	# Bedrooms	Septic Tank Size (gals)	Pump Tank Size (gals)	Pump Size (hp)	# of Pumps	Doses Per Day	Daily Design Volume (gals)	Gals/Dose	# Laterals	Waste Water Feed Location	Length (ft)	Disposal Bed Width (ft)	Area (sqft)	Fill Depth (ft)	Fill Type	Design Percolation Rate (min/in)	Design Permeability Rate (in/hr)
1	AvB	1.00	4	1000	750	1.00	2	4	650	162.5	9	central	36.0	30.0	1080	4	both	6.8	8.8
2	EvB	1.12	3	1500	1500	0.50	1	3	450	150.0	5	central	30.0	20.0	600	4	native	12.0	5.0
7	ArB	1.00	4	1000	500	0.50	2	4	650	157.9	5	central	42.0	21.0	882	8	select	-	-
10	EvB	1.00	4	2000	1500	0.50	1	4	650	163.0	6	central	39.5	22.5	889	4	select	3.1	19.4
11	DoA	1.01	4	1000	1200	1.00	1	4	650	196.2	7	central	52.0	21.0	1092	4	native	6.6	9.1
18	EyB	1.00	3	1000	1000	0.33	1	4	500	126.1	4	central	40.0	16.6	665	4	both	3.0	20.0
19	DoA	1.01	3	1000	750	0.50	1	4	450	112.5	4	end	40.0	15.0	600	4	native	3.0	20.0
20	DoB,LwB	1.00	4	1500	1500	0.33	1	4	650	162.5	5	end	43.5	20.0	870	4	native	-	-
Standard Systems																			
Site	Soil Series	Lot Size (ac)	# Bedrooms	Septic Tank Size (gals)	Pump Tank Size (gals)	Pump Size (hp)	# of Pumps	Doses Per Day	Daily Design Volume (gals)	Gals/Dose	# Laterals	Waste Water Feed Location	Length (ft)	Disposal Bed Width (ft)	Area (sqft)	Fill Depth (ft)	Fill Type	Design Percolation Rate (min/in)	Design Permeability Rate (in/hr)
9	DpB	1.01	3	1250	-	-	-	-	500	-	6	end	51.0	20.0	1020	4	native	6.0	10.0
12	DoA	1.01	3	1000	-	-	-	-	500	-	6	end	41.0	20.0	820	4	native	2.9	20.7
13	DoA	1.01	3	1000	-	-	-	-	500	-	6	end	41.0	20.0	820	4	native	3.0	20.0
15	EvB	2.45	4	1000	-	-	-	-	650	-	7	end	44.0	24.0	1056	4	select	7.2	8.3
17	DoA	0.90	3	1000	-	-	-	-	500	-	10	end	32.0	27.0	864	4	native	3.1	19.4
21	MmB	2.01	3	1000	-	-	-	-	500	-	8	end	34.0	24.0	816	12	select	6.1	9.8
22	AvB	2.01	3	1000	-	-	-	-	500	-	4	end	56.0	15.0	840	4	select	5.7	10.5
23	ArB	2.01	4	1250	-	-	-	-	650	-	8	end	44.0	24.0	1056	8	select	4.3	14.0
24	DoB	1.68	4	1500	-	-	-	-	650	-	7	end	44.0	24.0	1056	4	select	-	-
25	DxC	1.00	3	1000	-	-	-	-	500	-	7	end	44.0	24.0	1056	4	select	3.0	20.0
26	DxC	1.00	4	1000	-	-	-	-	650	-	9	end	46.0	30.0	1380	4	select	3.0	20.0

Key To Soil Types

ArB (Aura sandy loam)
 AvB (Aura-Downer sandy loam)
 DoA (Downer loamy sand)

DoB (Downer loamy sand)
 DpB (Downer sandy loam)
 DxC (Downer-Aura complex)

EwB (Evesboro sand)
 EyB (Evesboro fine sand)
 LwB (Lakewood fine sand)

MmB (Matawan loamy sand)

Appendix 2. USDA particle size distribution for select fill and native soil. I = imported sand used for the select fill layer. N = native soil used for the select fill layer. B = mixed imported soil with native soil for the select fill layer. UN = undisturbed native soil. Particle size reported as percentages. G = gravel (>2 mm), VCS = very coarse sand (1-2 mm), CS = coarse sand (0.5-1 mm), MS = medium sand (0.25-0.5 mm), FS = fine sand (0.1-0.25 mm), VFS = very fine sand (0.05-0.1 mm).

Pressure Dosing Systems

<u>System</u>	<u>Depth</u> (feet) (cm)	<u>Type of</u> <u>Sample</u>	<u>G</u>	<u>VCS</u>	<u>CS</u>	<u>MS</u>	<u>FS</u>	<u>VFS</u>	<u>S</u>	<u>C</u>	<u>Total</u> <u>Sand</u>	<u>Texture</u>	
1	0-0.5	0-15	B	20	17	16	17	21	17	2	10	88	sand
1	0.5-3	15-91	B	15	17	16	17	22	17	3	8	89	sand
1	3-4	91-122											no sample
1	4-5	122-152	UN	19	18	18	18	24	18	1	3	96	sand
2	0-0.5	0-15	N	22	23	19	17	22	14	3	3	95	sand
2	0.5-3	15-91	N	25	20	20	15	24	12	4	5	91	sand
2	3-4	91-122											no sample
2	4-5	122-152	UN	15	24	19	15	25	13	2	2	95	sand
7	0-0.5	0-15	I	16	17	15	17	24	10	8	10	82	loamy sand
7	0.5-3	15-91	I	17	17	17	17	24	11	6	10	85	sand
7	3-4	91-122	I	17	17	16	17	24	11	6	9	85	sand
7	4-5	122-152	I	19	17	16	17	25	10	8	8	84	loamy sand
10	0-0.5	0-15	I	9	15	21	16	31	8	5	3	91	sand
10	0.5-3	15-91	I	19	11	20	16	30	12	7	4	89	sand
10	3-4	91-122	I	16	4	21	19	31	13	10	2	88	sand
10	4-5	122-152	UN	9	23	16	18	25	10	5	3	92	sand
11	0-0.5	0-15	N	8	20	15	16	26	11	7	5	88	sand
11	0.5-3	15-91	N	5	21	15	16	26	9	5	7	87	sand
11	3-4	91-122	N	5	24	15	15	25	11	2	8	89	sand
11	4-5	122-152	UN	12	21	19	15	26	10	4	5	91	sand
18	0-0.5	0-15	B	5	18	18	18	23	18	2	4	94	sand
18	0.5-3	15-91	B	3	17	18	17	23	17	3	4	93	sand
18	3-4	91-122	B	8	17	17	18	23	18	3	4	93	sand
18	4-5	122-152	UN	2	18	18	18	23	18	3	4	94	sand
19	0-0.5	0-15	N	8	18	18	18	24	18	2	2	96	sand
19	0.5-3	15-91	N	8	18	18	18	24	18	2	2	96	sand
19	3-4	91-122	N	10	18	18	18	24	18	2	2	96	sand
19	4-5	122-152	UN	4	18	19	18	25	18	0	3	98	sand
20	0-0.5	0-15	N	2	18	18	18	23	18	2	3	95	sand
20	0.5-3	15-91	N	3	18	17	18	23	18	2	4	94	sand
20	3-4	91-122	N	4	18	18	19	24	18	0	4	97	sand
20	4-5	122-152	UN	0	18	19	18	25	18	1	2	98	sand

Appendix 2. (continued)

Standard Systems

<u>System</u>	<u>Depth</u> (feet) (cm)	<u>Type of</u> <u>Sample</u>	<u>G</u>	<u>VCS</u>	<u>CS</u>	<u>MS</u>	<u>FS</u>	<u>VFS</u>	<u>S</u>	<u>C</u>	<u>Total</u> <u>Sand</u>	<u>Texture</u>	
9	0-0.5	0-15	N	15	16	18	18	24	12	7	6	87	sand
9	0.5-3	15-91	N	17	17	17	17	22	11	7	10	83	loamy sand
9	3-4	91-122	N	6	17	16	17	22	11	7	10	83	loamy sand
9	4-5	122-152	UN	21	19	19	19	25	11	2	5	93	sand
12	0-0.5	0-15	N	5	19	20	19	26	9	5	1	94	sand
12	0.5-3	15-91	N	4	20	20	20	26	8	5	1	94	sand
12	3-4	91-122	N	4	19	18	19	25	8	7	4	89	sand
12	4-5	122-152	UN	5	19	19	18	25	10	5	4	91	sand
13	0-0.5	0-15	N	8	17	18	17	24	11	5	7	88	sand
13	0.5-3	15-91	N	8	18	18	18	24	11	7	3	90	sand
13	3-4	91-122	N	12	19	18	19	25	13	3	2	94	sand
13	4-5	122-152	UN	14	19	20	19	25	10	4	2	94	sand
15	0-0.5	0-15	I	2	19	19	20	26	10	4	1	95	sand
15	0.5-3	15-91	I	0	20	19	20	26	10	3	2	95	sand
15	3-4	91-122	I	1	19	20	19	26	10	3	2	95	sand
15	4-5	122-152	UN	0	17	17	16	22	14	12	2	86	sand
17	0-0.5	0-15	N	8	17	17	17	22	17	3	6	91	sand
17	0.5-3	15-91	N	6	17	17	17	22	17	5	6	89	sand
17	3-4	91-122	N	11	17	17	17	22	17	4	7	89	sand
17	4-5	122-152	UN	9	18	17	18	23	18	2	3	95	sand
21	0-0.5	0-15	I	6	17	17	17	22	17	4	6	90	sand
21	0.5-3	15-91	I	7	17	17	17	22	17	4	6	90	sand
21	3-4	91-122	I	10	16	16	16	21	16	8	8	85	sand
21	4-5	122-152	I	12	17	16	17	22	17	3	8	89	sand
22	0-0.5	0-15	I	6	16	17	16	21	17	6	7	87	sand
22	0.5-3	15-91	I	7	17	16	17	21	17	5	7	88	sand
22	3-4	91-122	I	6	17	16	17	22	17	4	7	89	sand
22	4-5	122-152	UN	3	17	17	17	22	17	2	8	90	sand
23	0-0.5	0-15	I	6	17	18	17	23	17	2	6	92	sand
23	0.5-3	15-91	I	10	17	15	17	22	17	4	7	88	sand
23	3-4	91-122	I	11	17	16	17	21	17	5	8	88	sand
23	4-5	122-152	I	16	16	15	16	20	16	5	12	83	loamy sand
24	0-0.5	0-15	I	10	17	18	17	23	17	3	5	92	sand
24	0.5-3	15-91	I	5	18	17	18	23	18	2	4	94	sand
24	3-4	91-122	I	2	18	18	18	23	18	2	3	95	sand
24	4-5	122-152	UN	5	18	17	18	23	17	2	5	93	sand

Appendix 2. (continued)

Standard Systems

<u>System</u>	<u>Depth</u> (feet) (cm)	<u>Type of</u> <u>Sample</u>	<u>G</u>	<u>VCS</u>	<u>CS</u>	<u>MS</u>	<u>FS</u>	<u>VFS</u>	<u>S</u>	<u>C</u>	<u>Total</u> <u>Sand</u>	<u>Texture</u>
25	0-0.5 0-15	I	4	18	17	18	23	17	3	4	93	sand
25	0.5-3 15-91	I	4	17	18	17	24	17	2	5	93	sand
25	3-4 91-122	I	1	17	18	17	24	17	3	4	93	sand
25	4-5 122-152	UN	16	17	18	17	23	17	3	5	92	sand
26	0-0.5 0-15	I	6	17	17	18	24	18	2	4	94	sand
26	0.5-3 15-91	I	5	18	17	18	23	18	2	4	94	sand
26	3-4 91-122	I	3	18	17	18	23	18	2	4	94	sand
26	4-5 122-152	UN	6	17	18	17	23	18	2	5	93	sand